

Electro-Tyfon® MTX 150/120

For vessels of 200 m or more in length

Serial No. _____



Contactor Unit TK 80A/TK 90A

See separate leaflet KSM 604/0401

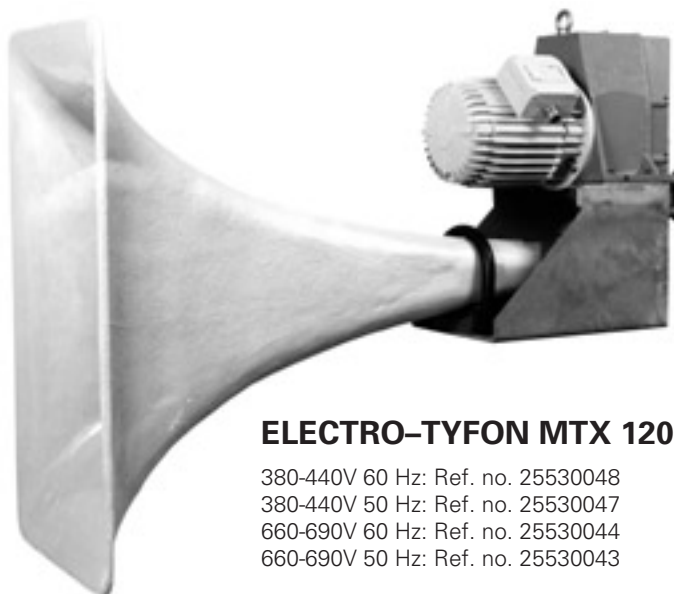

ELECTRO-TYFON MTX 120

380-440V 60 Hz: Ref. no. 25530048

380-440V 50 Hz: Ref. no. 25530047

660-690V 60 Hz: Ref. no. 25530044

660-690V 50 Hz: Ref. no. 25530043

General Information

ELECTRO-TYFON® MTX 150 is an electrically driven piston emitter. It is built-up of comparatively few moving parts as the "swinging piston", unlubricated cylinder and an oil-free gearbox. The main important features are the following:

- unsymmetrical sound distribution
- operates in all ambient temperatures
- unaffected by voltage and frequency fluctuations
- maintenance-free and non-corrosive
- easy to install
- complies fully with the International Regulations IMO 1972.

Unsymmetrical Sound Distribution

The IMO Regulations stipulate a very high sound pressure level for efficient signalling, yet the sound level of the vessel's own signal at the listening posts shall not exceed 110 dBA. A common way to solve this "paradox" is to place the whistle very high above deck. But what if the highest point is not high enough? For example: to reduce the noise from the signal by 6 dB, the distance between the listening post and the whistle must be doubled!

ELECTRO-TYFON MTX 150 with unsymmetrical Sound Distribution is the solution. The new horn with its unique vertically extended front, and a specially created sound spectrum will reduce the noise on deck with 6-8 dB compared to a conventional whistle.

Operates in all Temperatures

ELECTRO-TYFON MTX 150 will give a high performance in both arctic and tropical climates. A patented system with a high efficiency rectangular horn and a specially designed motor will match the motor speed to the acoustic resonance of the horn at any ambient temperature. This system also prevents the whistle from being affected by voltage and frequency fluctuations in onboard mains.

Maintenance-free

All components are chosen to withstand corrosion and to give a minimum of maintenance. The crankcase, motor and foundation is hot galvanized. The horn is made of glass fibre polyester (white). The cylinder is unlubricated and the gearbox is oil-free. The piston rod bearing includes a grease reservoir with a special device to minimize the grease losses.

Motor Control

Our complete Contactor TK 80/TK90A is available for ELECTRO-TYFON MTX 150 and has following functions:

- Motor start
- Motor overload protection
- Winding heating of motor for anti-condensation purpose.

Technical Data

Frequency (basic): 120 Hz

Sound Pressure Level (notional distance 1 m)

According to IMO (1/3 octave band): >143 dB

Weight (approx): 90 kg

G = galvanized model

Dimensions and Installation

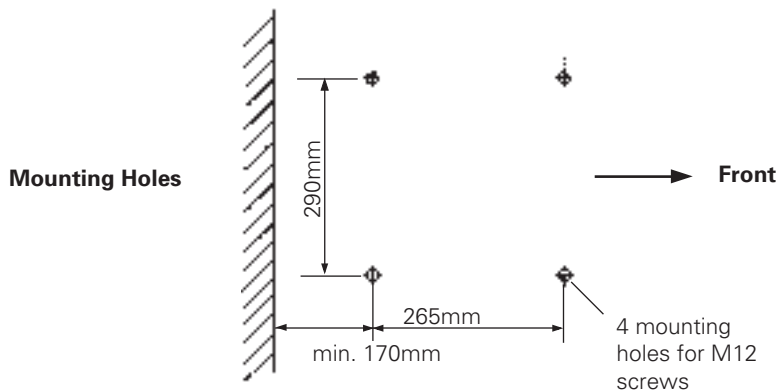
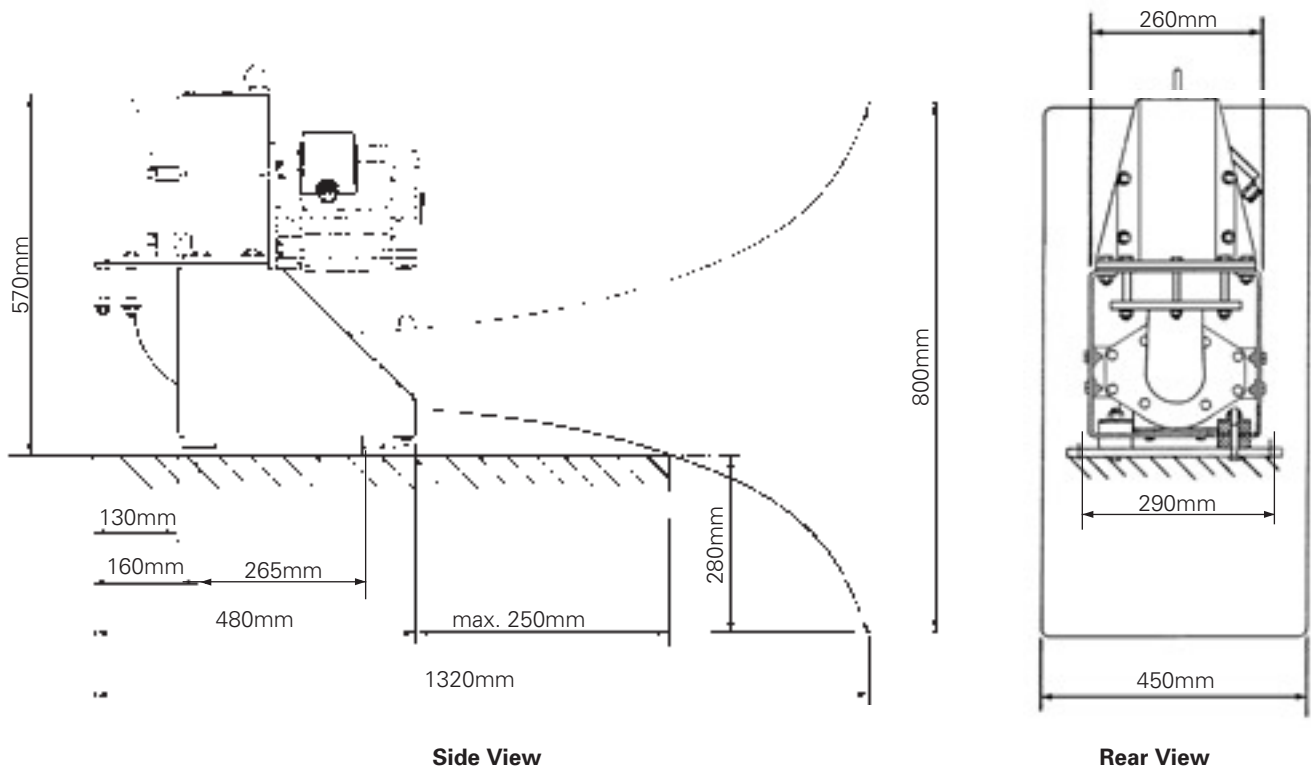

Installation

ELECTRO-TYFON MTX 150 shall be fixed with four M12 screws that must be firmly tightened and locked.

Mount the whistle on a platform supplied with a safety rail.

As the whistle is subject to vibration on starting and stopping, flexible electric cables should be used nearest the motor.

The gland on the electric Motor Terminal Box is Pg 21 for cable Ø 16,5–19,5.

ELECTRO-TYFON MTX 150/120			
Voltage 50/60 Hz	380-440	660-690	230
Power consumption kVa	11	11	11
In -rush current A	60	36	96
Fuse (slow) A	20	16	25
Power cable section, mm ²			
Lenght up to 100 m	4	2,5	6
Lenght 100-200 m	6	4	10
Lenght 200-300 m	10	6	16

Maintenance, Dismantling and Reassembling

Maintenance

ELECTRO-TYFON is designed to give long reliable service without routine maintenance, but a periodic inspection always gives early warning of any faults that may develop.

Dismantling the Whistle The Piston and Rod

Inspection or change of cylinder, piston, piston rings, rod and rod bearing can be done without removing the crankcase from the foundation in the following way:

- Shut off and block the electric supply.
- Dismount the horn (D) and outlet pipe (C).
- Unscrew the crankcase cover (B).
- Remove the cylinder (H) with a sharp tool between the cylinder and the base plate (L).
- Loosen the piston screw (J). When loosening, counterhold with a spanner on the flat surfaces of the piston rod just above the piston to avoid twisting the rod. Remove the piston (I).
- Unscrew the bearing cover (E) of the rod (G) remove the circlip (F1) from the crank journal and pull apart the rod with a puller.

The Motor

To remove the motor, the crankcase/motor unit has to be dismantled from the foundation. After dismantling the piston, remove the base plate from the gear housing. Do not forget to loosen the screw (K) inside the cylinder. Unscrew the motor screws (A), lift the motor and remove it through the channel in the crankcase.

The Crankshaft

Unscrew the four M10 nuts (M) inside the crankcase and remove the mounting flange.

Unscrew the M8 screw (Q) in the crankshaft bearing cover at the motor side of the crankcase. Install a long M8 screw in the thread and pull out the cover.

Remove the spacer O-ring and circlip (F2) at the end of the crankshaft and press out the crankshaft from the motor side of the crankcase. The drive end bearing (P) is fixed in the crankcase, and the balance end bearing (R) moves out with the crankcase.

Do not remove the two bearing location screws (O) inside the crankcase.

General Inspection

There must be no scratches or nicks on the inside surface of the cylinder. A slight clearance between the piston ring and cylinder is quite normal. Replace the piston ring if the thickness is below 5,5 mm.

Reassembling

When replacing the gear wheel (N) at the motor, heat the new wheel to about 80°C before pressing it on the motor shaft.

Lubricate the teeth of the gear wheel with Molybdenum or tungsten disulfide grease of good quality intended for high-speed gears.

Lubricate the piston rod bearing and fill half of the volume inside the bearing cover with high-speed roller bearing grease of good quality for example: Klüber Isoflex LDS 18 Special A.

Important

On inspection or change of cylinder, always replace O-rings, circlips, the piston rod sealing ring and piston screw securing plate with new ones. Lock all screws with Loctite 242 or similar locking liquid.

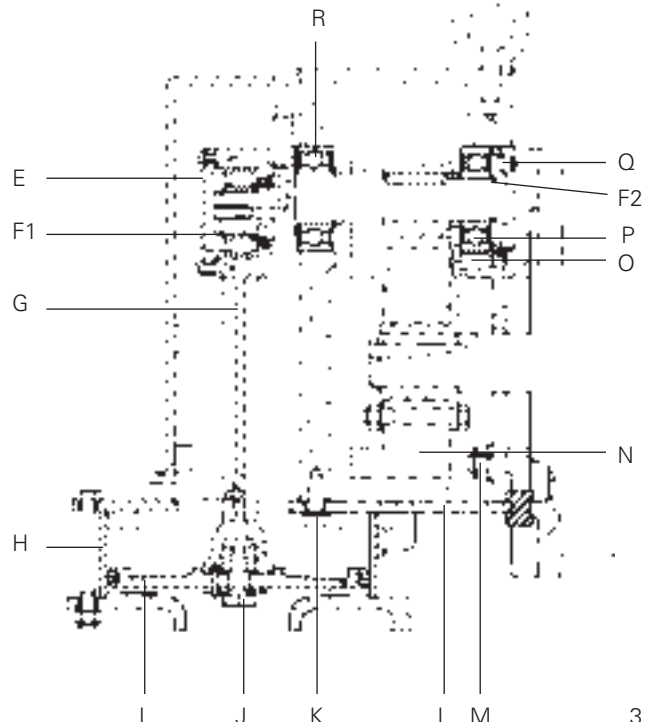
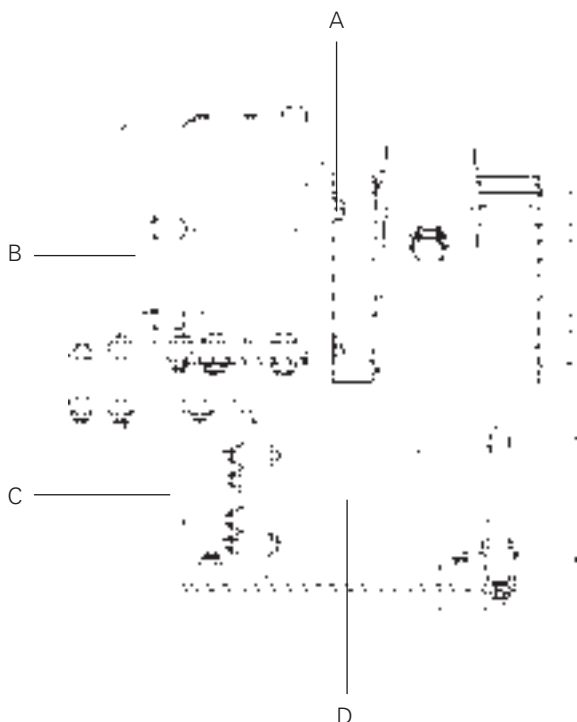

MTX 150/120: Part No.

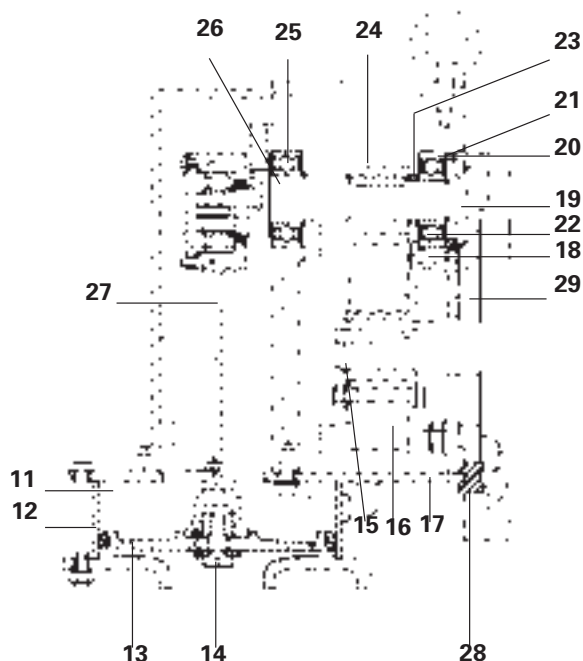
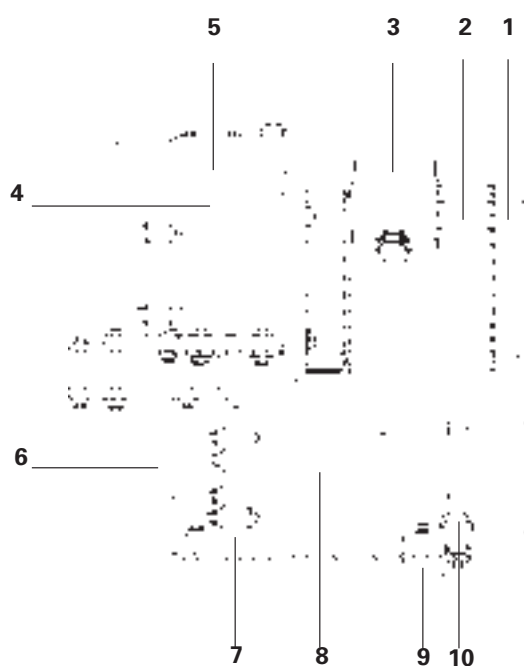

No.	Ref.no.	Item	Qty.
1	34240705	Bearing (2 in set) for motor	2
2*	20611031	Motor type R 112 MBF/2-R 440/440V	1
2	20611029	Motor type R 112 MBF/2-R 690V	1
3	-----	Connectiong box compl.	1
4	21769059	Cover	1
5	21769397	Crankcase	1
6	21768984	Outlet	1
7	21768049	Packing	1
8	21750120	Horn	1
11	21768368	Flange	1
12	21769402	Cylinder	1
15	32470028	Circlip SgA 28	1
16	24530306	Motor Gear Wheel, 50 Hz	1
16	24530307	Motor Gear Wheel, 60 Hz	1
17	21768365	Base plate	1
18	21769060	Screw	2
19	21768399	Cap	1
20	21768404	Spacer	1
21	20862066	O-ring 57,6 x 2,4	1
22	20880003	Bearing for Crankshaft	1
23	21768376	Spacer	1
24	-----	Crankshaft Gear Wheel	1
	21769399	400V 50 Hz	
	21769401	440V 60 Hz	
25	34240406	Bearing for Crankshaft	1
28	21768474	Sealing	1
29	21768473	Mounting flange	1

No.	Ref. no.	Set Complete
9	24530293	Vibration Damper Set Vibration Damper Bushing Washer Nut
10	24530294	Clamp Set Clamp Slang Support Plastic Spacer Rubberpacking
13	24530296	Piston Set Piston Piston rings 2 in set Pin
14	24530297	Mounting Set forPiston/Piston Rod Washer Screw
26	24530292	Crankshaft Set Crankshaft Flat Key Screw Stopscrew Circlip 30 / 25
27	24530291	Piston Rod Set Piston rod Cap Nut Bearing Radial seal O-ring Screw Washer Circlip

Units can be obtained from Kockum Sonics or their agents. When ordering, please, give reference number and part name.

*The motor is the same for 400V/50 Hz and 440V/60 Hz, only the gear wheels are different.

Subject to alteration without notice.